

# iLuv™

## **Portable Multimedia Tablet Style DVD Player with 7" Active-Matrix TFT LCD Screen**



**i1055**

## **INSTRUCTION MANUAL**





**Please read this manual carefully before operating and  
save it for future reference.**

**Have a question? Please visit [www.i-Luv.com](http://www.i-Luv.com)**



**USER SAFETY GUIDE**

**IMPORTANT SAFETY PRECAUTIONS**

	<div style="background-color: #cccccc; padding: 10px; display: inline-block;"><b>CAUTION</b></div> <b>RISK OF ELECTRIC SHOCK DO NOT OPEN</b>	
	<p>The lightning flash with an arrowhead symbol within an equilateral triangle is intended to alert the user of the presence of un-insulated “dangerous voltage” within the unit’s cabinet that may be of sufficient magnitude to constitute a risk of electric shock.</p>	
	<p>The exclamation point within an equilateral triangle is intended to alert the user of the presence of important operating, maintenance and servicing instruction in the manual accompanying the unit.</p>	

**WARNING:** To prevent fire or shock hazard, do not expose this appliance to rain or moisture.

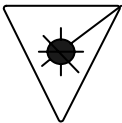
	<p><b>CLEANING</b></p> <p>Always disconnect unit from power supply before attempting to clean it. Use soft cloth moistened with soapy water, and wipe gently. Do not use solvents or abrasive materials.</p>	
<div style="border: 2px solid black; padding: 5px; margin-bottom: 10px;"> <p>CLASS 1 LASER PRODUCT LUOKAN 1 LASERLAITE KLASS 1 LASERAPPARAT</p> </div> 	<p><b>LASER SAFETY</b></p> <p>This unit uses laser technology. Only a qualified professional should remove the cover or attempt to service this device, due to possible eye injury.</p> <p><b>CAUTION – CLASS 1 LASER PRODUCT</b></p> <p>Use of controls adjustments and/or performance of procedure other than specified herein may result in hazardous radiation exposure.</p> <p><b>DANGER</b></p> <p>Invisible laser radiation when open and interlock failed or defeated. Avoid direct exposure to beam. <b>CAUTION: HAZAROUS LASER RADIATION WHEN OPEN AND INTERLOCK DEFEATED.</b></p>	

## USER SAFETY GUIDE

### IMPORTANT SAFETY PRECAUTIONS

#### You can help to protect the environment!

Please remember to respect the local regulations: Bring all non-working electrical equipment to an appropriate waste disposal center.



#### FOR RECHARGEABLE BATTERY

Attention: NI-MH must be recycled and disposed of properly.

### IMPORTANT SAFETY WARNINGS

1. FCC regulations state that any change or modification to the equipment, not expressly approved by maker or its authorized parties, could void user's authority to operate this equipment.
2. To prevent fire or electric shock, do not expose the unit to water, rain, or moisture.
3. Never attempt to open the cabinet. Dangerous high voltages are present in the unit. Always refer servicing to a qualified technician.
4. Before using the player please ensure that your local AC voltage is suitable for this unit.

### IMPORTANT SAFETY INSTRUCTIONS

1. **READ INSTRUCTIONS** - All the safety and operating instructions should be read before the appliance is operated.
2. **RETAIN INSTRUCTIONS** - The safety and operating instructions should be retained in a secure place for future reference.
3. **HEED WARNINGS** - All warnings on the appliance and in the operating instructions should be adhered to.
4. **FOLLOW INSTRUCTIONS** - All operating and use instructions should be followed.
5. **WATER AND MOISTURE** - The appliance should not be used near water. For example: near a bathtub, kitchen sink, laundry tub, and/or swimming pool.
6. **VENTILATION** - The appliance should be situated so that its location and position does not interfere with its proper ventilation. For example, the appliance should not be situated on a bed, sofa, rug or similar surface that may block the ventilation openings; or, be placed in a built-in installation, such as a bookcase or cabinet that may impede the flow of air through the ventilation openings.
7. **HEAT** - The appliance should be situated away from heat sources such as radiators, heat registers, stoves, or other appliances (including amplifiers) that produce heat.
8. **POWER SOURCES** - The appliance should be connected to a power supply only of the type described in the operating instructions or as marked on the appliance.
9. **POWER CORD PROTECTION** - Power supply cords should be routed so that they are not likely to be walked on or obstructed by items placed on or against them. Pay particular attention to cords at plugs, convenience receptacles, and the point at which they connect to the appliance.

**USER SAFETY GUIDE****IMPORTANT SAFETY INSTRUCTIONS – CONTINUED**

10. **CLEANING** - The appliance should be cleaned with a dry cloth.
11. **NONUSE PERIODS** - The power cord of the appliance should be unplugged from the outlet when the appliance is to be left unused for an extended period of time.
12. **OBJECT and LIQUID ENTRY** - Care should be taken so that objects do not fall and liquids are not spilled into the device's openings.
13. **CARTS AND STANDS** - The appliance should be used only with a cart or stand that is recommended by the manufacturer. An appliance and cart combination should be moved with care. Quick stops, excessive force, and uneven surfaces may cause the appliance and cart combination to overturn 
14. **DAMAGE REQUIRING SERVICE** - The appliance should be serviced by qualified service professional when:
  - a. The power-supply cord or plug has been damaged.
  - b. Objects have fallen into, or liquid has been spilled into the appliance's apertures.
  - c. The appliance has been exposed to rain.
  - d. The appliance has been dropped and suffered damage.
  - e. The appliance does not appear to operate normally, or exhibits a change in performance.
15. **SERVICING** - The user should not attempt to service the appliance beyond what is described in the user's operating instructions. All other servicing should be referred to qualified service professional.
16. **BATTERY USAGE** – To prevent battery leakage, which may result in bodily injury, property damage or damage to the unit, follow these instructions:
  - a. Install all batteries correctly according to the polarity (+ -) as marked on the unit.
  - b. Do not mix old and new batteries, carbon and alkaline, etc.
  - c. Remove batteries from the unit when the device will not be used for an extended period of time.
17. **LEAD AND MERCURY** - This product may contain lead and/or mercury. Disposal of these materials may be regulated by your local authorities due to environmental considerations. For more detailed disposal or recycling information, please contact your local authorities or the EIA (Electronic Industries Alliance) – <http://www.eiae.org>

**FCC RULE**

This device complies with Part 15 of the FCC Rules. Operation is subject to the condition that this device does not cause harmful interference.

**Note: Changes or modifications not expressly approved by the party responsible for compliance could void the user's authority to operate the equipment.**

## TABLE OF CONTENTS

### GETTING STARTED

Compatibility .....	7
General features .....	9
Location of controls on the remote control .....	10
Location of controls on the main unit .....	11
How to make your player stand .....	12
First time to use the remote control .....	12
Remote control battery installation .....	12
Using the AC adapter .....	12
Charging your DVD player .....	13
Battery low indication .....	13
Using the cigarette lighter adapter .....	13
Installing the dock adapter for your iPod .....	13
Charging your iPod .....	13
Connecting headphones .....	14
Connecting the DVD player to a TV set by AV cable .....	14
Connecting the DVD player to a TV set by S-Video cable .....	14
Connecting other media to the DVD player .....	14

### BASIC OPERATION

Watching your iPod videos on the 7" LCD screen .....	15
Playing a DVD / VCD / Audio CD / MP3 Disc.....	17
MP3 file browser .....	18
Loading an MP3 CD .....	18
Playing an MP3 file in the root folder .....	18
Playing an MP3 File in a folder .....	19
Selecting the MP3 file using numeric buttons .....	19
Going back to the previous folder .....	19
Repeat play of MP3 files .....	19
Playing a JPEG CD .....	20

### OPERATIONAL FEATURES

Panel key lock .....	21
Invalid icon .....	21
LCD screen on / off function .....	21
DVD menu feature .....	21
Subtitle feature .....	21
Audio menu feature .....	21
Audio mode .....	21
Mute function .....	21
3D sound .....	22

## TABLE OF CONTENTS

### OPERATIONAL FEATURES – CONTINUED

Zoom function .....	22
PBC function .....	22
Random function .....	22
Skip and search function .....	22
Title / chapter search function .....	23
Title / time search function .....	23
Repeat function .....	23
A-B repeat function .....	24
Viewing from a different camera angle (multi-angle) .....	24
Programmed playback .....	24
Display feature .....	25
Bookmark feature .....	25
Digest function .....	26

### SETTING UP YOUR DVD PLAYER

Navigating the setup pages .....	27
General setup pages .....	28
Speaker setup pages.....	28
Video Setup Page.....	29
Preference Setup Page.....	29

### CARE AND MAINTENANCE GUIDE

Cleaning the unit .....	30
-------------------------	----

### TROUBLESHOOTING GUIDE

Q & A about the product.....	31
------------------------------	----

### TECHNICAL INFORMATION

Specifications.....	33
---------------------	----

## GETTING STARTED

### COMPATIBILITY

	<b>AUDIO AND VIDEO</b>	<ol style="list-style-type: none"> <li>1. Disc Size: 12cm / 8cm</li> <li>2. Disc Type: DVD             <ol style="list-style-type: none"> <li>a. Single side, single layer</li> <li>b. Single side, double layer</li> <li>c. PAL / NTSC</li> </ol> </li> </ol>
	<b>AUDIO AND VIDEO</b>	<ol style="list-style-type: none"> <li>1. Disc Size: 12cm / 8cm</li> <li>2. Disc Type: SVCD / VCD</li> <li>3. Playback time 74 min./ 24 min. max</li> </ol>
	<b>AUDIO CD</b>	<ol style="list-style-type: none"> <li>1. Disc Size: 12cm / 8cm</li> <li>2. Disc Type: CD</li> </ol>
	<b>MP3 CD</b>	<ol style="list-style-type: none"> <li>1. Disc Size: 12cd / 8cm</li> <li>2. Disc Type: CD</li> <li>3. File Format: MP3 (MPEG 1 Audio Layer 3)</li> <li>4. Bit Rate: 32Kbps ~ 320Kbps</li> </ol>
	<b>DIGITAL MEDIA PLAYER</b>	<ol style="list-style-type: none"> <li>1. Made for iPod with video (30GB, 60GB) only.</li> <li>2. iPod is a trademark of Apple Computer, Inc.</li> </ol>

### DISC ERROR

This compact disc player has built-in error compensation circuits to correct for minor defects in a disc. There are limits, however, to the amount of correction available. In some cases, the DVD player may skip some tracks, or parts of tracks, on a disc during disc play. This problem may be caused by defects (such as scratches) in the disc being played, which are too large for the error compensation circuits to handle. If you encounter this problem, try a new disc before having this unit serviced. If the DVD player operates normally, the skipping problem is probably due to a defective disc.

**Note:** Only the above types of discs can be played on this unit. Some CD-R, CD-RW discs cannot be played depending on the condition of the disc.



## GETTING STARTED

### MP3 (MPEG 1 Audio Layer 3)

MP3, technically referred to as MPEG 1 Audio Layer 3, is one of the popular digital audio encoding and lossy compression formats. This encoding format was developed to reduce the amount of data (or audio information) required to represent audio, yet to still reproduce audio as same as the original uncompressed audio for most listeners.

**This product incorporates copyright protection technology that is protected by method claims of certain U.S. patents and other intellectual property rights owned by Macrovision Corporation and other rights owners. Use of this copyright protection technology must be authorized by Macrovision Corporation, and is intended for home and other limited viewing uses, only unless otherwise authorized by the Macrovision Corporation. Reverse engineering or disassembly is prohibited.**

**Apparatus claims of US Patent Nos. 4,631.603; 4,819.098; 5,315.448 and 6,516.132; licensed for limited viewing uses only.**

## GETTING STARTED

Thank you for purchasing i1055. Unpack the unit and make sure all the accessories are put aside so they will not be lost. We recommend that you retain the original carton and packaging materials for future use, should you transport or ship the unit in the future.

### 7" Portable Multimedia Tablet Style DVD Player for Your iPod with video

#### Features for Your iPod

- Play back video content from your iPod through the 7" widescreen (16:9 aspect ratio) TFT LCD
- Charge your iPod with video\*
- Integrated dock for your iPod with video (30GB, 60GB)



#### Features for DVD Player

- Play back DVD video through the 7" widescreen (16:9 aspect ratio) TFT LCD
- Watch your favorite video on TV through S-Video output
- Enhanced user interface with detailed controls
- Convenient OSD (On-Screen Display)
- Multiple subtitle, angle, and audio functions
- Slow or fast motion playback and zoom operation
- Supports 3-way power sources
  - AC Power Adapter
  - Cigarette Lighter Adapter
  - Built-in Ni-MH Rechargeable Battery
- Playable Media: DVD / VCD / Audio CD / MP3 CD

#### In the Box

- Main unit
- Remote control (battery included)
- Cigarette lighter adapter
- AC adapter
- AV cable
- Strap for car-seat display
- Instruction manual
- Warranty card

\* The included power adapters must be connected to the main unit in order to charge your iPod.

## GETTING STARTED

### Location of Controls on the Remote Control

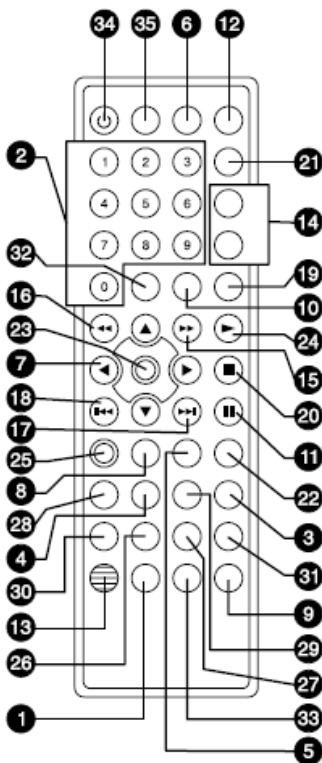

1. KEY LOCK BUTTON
2. NUMBER 0 TO 9 BUTTON
3. DVD MENU BUTTON
4. TITLE MENU BUTTON
5. PBC BUTTON
6. DISPLAY BUTTON
7. NAVIGATION (◀ / ▶ / ▲ / ▼) BUTTON
8. RETURN BUTTON
9. BOOKMARK BUTTON
10. SLOW REVERSE BUTTON
11. PAUSE / STEP BUTTON
12. RANDOM BUTTON
13. MUTE BUTTON
14. REPEAT / REPEAT A-B BUTTON
15. SEARCH FORWARD BUTTON
16. SEARCH REVERSE BUTTON
17. SKIP FORWARD BUTTON
18. SKIP REVERSE BUTTON
19. SLOW FORWARD BUTTON
20. STOP BUTTON
21. PROGRAM BUTTON
22. SEARCH BUTTON
23. ENTER BUTTON
24. PLAY BUTTON
25. SETUP BUTTON
26. 3D BUTTON
27. ANGLE BUTTON
28. SUBTITLE MENU BUTTON
29. AUDIO MENU BUTTON
30. AUDIO MODE BUTTON
31. ZOOM BUTTON
32. CLEAR BUTTON
33. DIGEST BUTTON
34. STANDBY ON / OFF BUTTON
35. SCREEN ON / OFF BUTTON

#### IMPORTANT NOTE

The included remote control doesn't have any control on your iPod. To control your iPod, please use the control buttons on your iPod.

Point the remote control unit no more than 6m from the remote sensor and within about 30° of the front of the unit.

# GETTING STARTED

## Location of Controls on the Main Unit

### Top View

1. Phone Jack #1
2. Phone Jack #2
3. Volume Control Knob
4. Input / Output / iPod Select Switch
5. S-Video Jack
6. Video Jack
7. Audio Jack
8. Power On / Off Switch
9. DC IN Jack

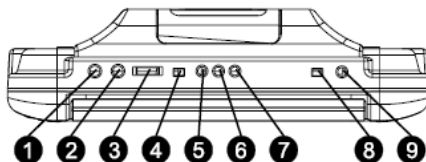

### Front View

10. Built-in Stereo Speakers
11. Enter Button
12. Navigation (▲/▼/◀/▶) Buttons
13. Pause Button
14. Skip Forward Button
15. Skip Reverse Button
16. Remote Control Sensor
17. Standby Indicator
18. Charge Indicator
19. Full Indicator
20. 7" TFT LCD Screen
21. Disc Compartment Cover
22. Setup Button
23. Title Menu Button
24. DVD Menu Button
25. Display Button
26. Play Button
27. Stop Button

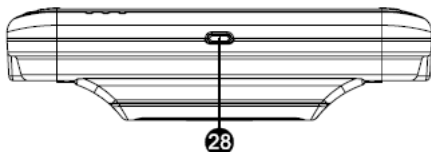
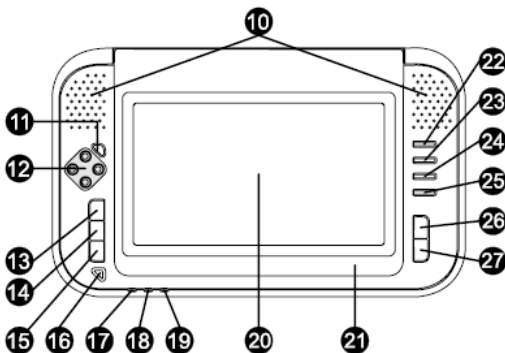

### Bottom View

28. Open Button for Disc Compartment Cover

### Back View

29. Desktop Stand
30. Integrated Dock for iPod with video

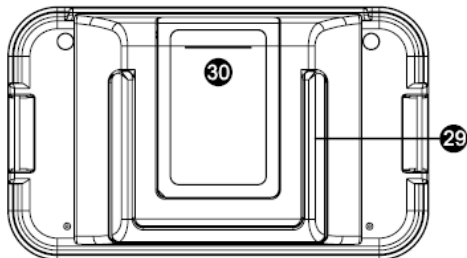

**Note:** To activate buttons on the main unit, press and release the button each time. (From button no. 11-15, 22-27)

## GETTING STARTED

### How to Make Your Player Stand

Follow the illustrations below to make your player stand.

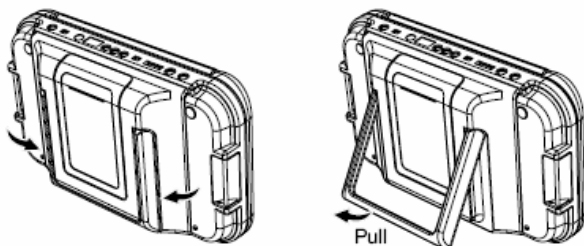

Pull out the **STAND** at the back of the unit gently. Then, carefully stand the unit.

### First time to Use the Remote Control

The battery is pre-installed in the remote control with the insulation plate. Before starting to operate the remote control, please pull out the insulation plate from the battery compartment.

### Remote Control Battery Installation

If the remote control does not work or the signal gets weaker, the battery might weaken. In that case, please replace the battery.

1. Pull out the battery holder as shown right.
2. Place one battery (CR 2025) as shown right. Make sure that the polarity (+/-) of battery matches the marks inside the unit.
3. Insert the battery holder into its compartment as shown right.

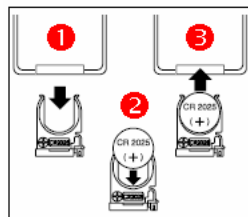

**Note:** Do not attempt to recharge, short-circuit, disassemble, heat or throw the batteries into a fire.

### Using the AC Adapter

1. Insert the DC plug at the end of the adapter cord into the **DC IN** jack at the top side of the player.
2. Plug the other end into an AC wall outlet.

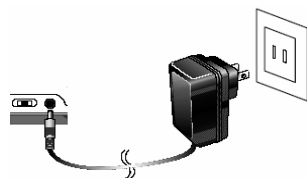

**Note:** Only use with the supplied AC adapter. Using with another AC adapter could cause damage. Remove both the DC plug and AC plug to disconnect the AC adapter when not necessary.

## GETTING STARTED

### Charging Your DVD Player

Before using this unit with the built-in Ni-MH rechargeable battery, please **FULLY CHARGE THE BATTERY** first. If this is not done, the discharging time will be short. The battery will be operated normally with maximum capacity after 4~5 times of charging and discharging. After a period of storage, or non-usage for an extended period of time, please fully charge the battery again before using it. The battery is fully charged for approximately 4-5 hours after the AC adapter is connected.

1. Connect to the AC adapter according to the instructions in the section "Using the AC Adapter".
2. Switch the unit OFF to recharge the battery. The battery recharge circuit operates in the **OFF** mode. While the battery is charging, the **CHARGE** indicator at the front will light up **RED**. When charging is complete, the **FULL** indicator will light up **GREEN**.
3. Disconnect the AC adapter plugs from both the player and the AC outlet, when charging is complete or not necessary.

### Battery Low Indication

When using the rechargeable battery to play and the battery is nearly exhausted, the **STANDBY** indicator in the front of the player will begin blinking. After some time, the power will turn OFF automatically. Refer to the instructions in the section "Charging the Battery" to recharge the battery.

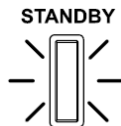

### Using the Cigarette Lighter Adapter

Plug the small end of the cigarette lighter adapter into the **DC IN** jack and then plug the other end into the cigarette lighter socket.



### Installing the Dock Adapter for Your iPod

Open the dock cover on the back of the main unit and install the correct dock adapter for your iPod. The "30GB" dock adapter is for iPod with video (30GB), and the "60GB" dock adapter is for iPod with video (60GB).

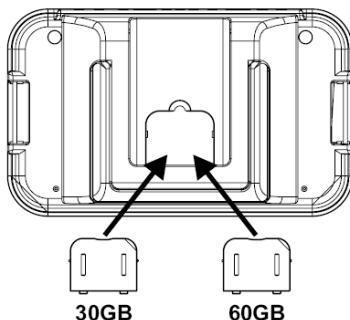

### Charging Your iPod

The player cannot supply the power to charge the iPod without the AC adapter connected.

1. Insert your iPod into the dock carefully and close the dock cover.
2. Connect the supplied AC adapter to the unit. It will automatically charge your iPod.
3. Disconnect the AC adapter when not necessary.

**Note:** Only use with the supplied AC adapter. Using another AC adapter can damage this unit or the iPod.

## GETTING STARTED

### Connecting Headphones

Use 3.5mm stereo headphones with this product.

**Note:** Please note that hearing experts advise not to use headphones with high volume for long periods of time. It may damage your hearing to do so.

### Connecting the DVD Players to a TV Set by AV Cable

Use the AV cable (3.5mm to RCA) to connect the DVD player to the TV set and amplifier. The yellow-colored plug is used for Video. The white-colored plug is for Audio L and the red-colored plug for Audio R.

### Connecting the DVD Player to a TV Set by S-Video Cable (S-Video Cable NOT Included)

Use the S-Video cable (3.5mm to DIN) to connect the DVD player and TV set.

### Connecting Other Media to the DVD Player

Use the AV cable (3.5mm to RCA) to connect from other media to the DVD player. The yellow-colored plug is used for Video. The white-colored plug is for Audio L and the red-colored plug for Audio R.

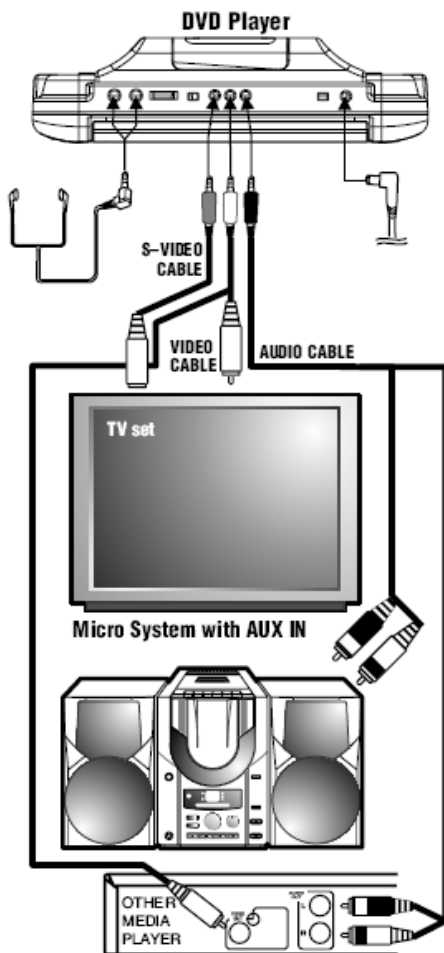

**Note:** Slide the **LINE SELECT** switch to the **IN** position to receive the AV signal from other external devices. To receive an AV signal from iPod with video, please slide the **LINE SELECT** switch to the **iPod** position.

## BASIC OPERATION

### Watching Your iPod Videos on the 7" LCD Screen

To see your favorite iPod videos on the 7" LCD screen, follow the instructions below:

1. On the menu screen of your iPod, select the "Videos" option.



2. On the next menu screen, select the "Video Settings" option.

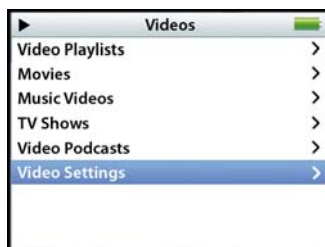

3. On the next menu screen, select the "TV Out" option and set it on.

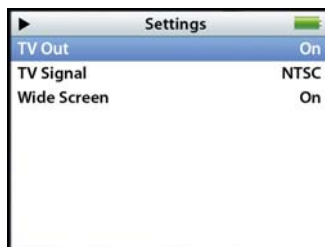

4. Open the dock cover on the back of the main unit and install the correct dock adapter for your iPod if you haven't installed the dock adapter yet.

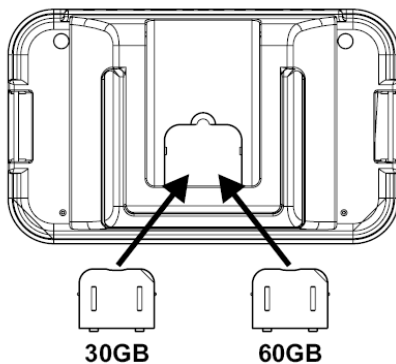



## BASIC OPERATION

### Watching Your iPod Videos on the 7" LCD Screen – Continued

5. Insert your iPod into the dock carefully and close the dock cover.

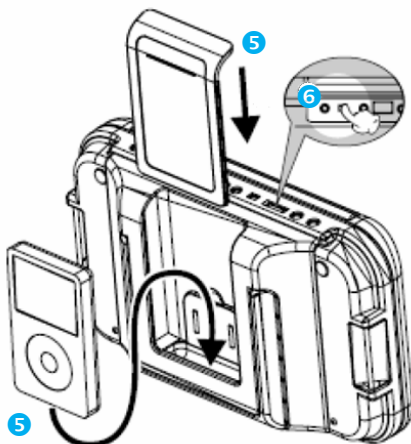

6. Set the “**LINE SELECT**” switch on the top of the main unit to the “**iPod**” position.

7. Connect the AC adapter to the main unit and set the “**POWER**” switch on the top of the main unit to the “**ON**” position.

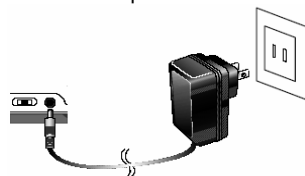

8. Navigate the menu screen of your iPod to your favorite video file.

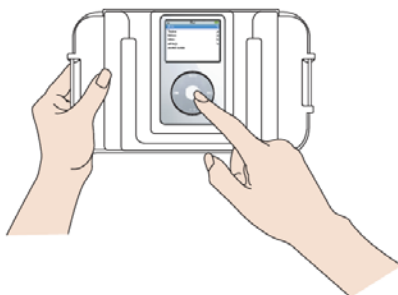

9. Play the video file and watch it on the 7" LCD screen. Please note that the DVD player and remote control don't have any control on your iPod due to the limited navigation system of iPod with video (30GB, 60GB).

## BASIC OPERATION

### Playing DVD / VCD / Audio CD / MP3 CD

1. To power the unit on, slide the **POWER** switch at the top of the unit to the **ON** position.
  - a. To select the type of the power source, please refer to the portion of the manual entitled as "**GETTING STARTED**".
  - b. To see a movie on the LCD screen of i1055, the **LINE SELECT** switch must be in the **OUT** position.

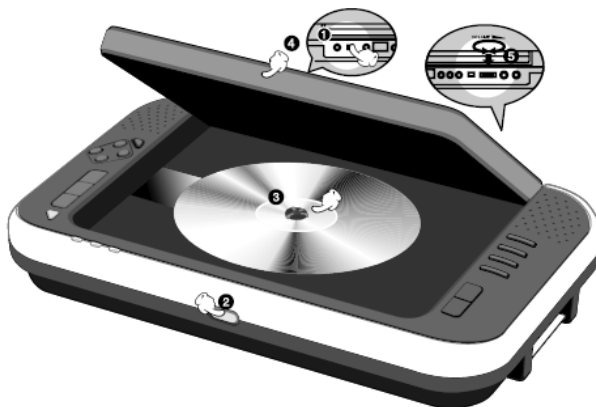

2. Press the **OPEN** button to open up the disc compartment cover. The **OPEN** indication will appear on the LCD screen.
3. Place the disc with the label side facing up into the disc compartment. Hold the disc without touching either of its surfaces while placing it in to the disc compartment.
4. Push the cover down to close and secure. The disc will start playback automatically.
  - a. If playing a DVD disc, the **MENU** options will appear on the LCD screen, depending on a DVD disc. Use the **NAVIGATION** (◀ / ▶ / ▲ / ▼) buttons to select the **PLAY** option. Press the **ENTER** button to play the disc.
  - b. If playing a VCD disc or Audio CD, it will automatically play the video or audio track. If not automatically played, press the **PLAY** (▶) button to start playing.
  - c. For a MP3 disc, the disc reading time may exceed a little bit longer, due to the large number of songs compiled onto one disc. Select the song and press the **ENTER** or **PLAY** (▶) button to play.
5. Adjust the **VOLUME CONTROL** knob to set the volume to a comfortable sound level.
6. Press the **STOP** (■) button once while playing a DVD disc and the indication "**Press PLAY Key to Continue**" will appear on the screen. The player then memorizes the point where you stopped. When you press the **PLAY** (▶) button again, it will start playing the movie automatically from the point where it was stopped.
7. Press the **STOP** (■) button twice while playing a movie to completely stop the playback.

**Note:** When i1055 is in the **PLAY** mode and the **STANDBY** indicator is blinking, it signifies the battery is nearly exhausted and must be recharged. Refer to the "**Charging the Battery**" section to recharge the battery.

# BASIC OPERATION

## MP3 File Browser

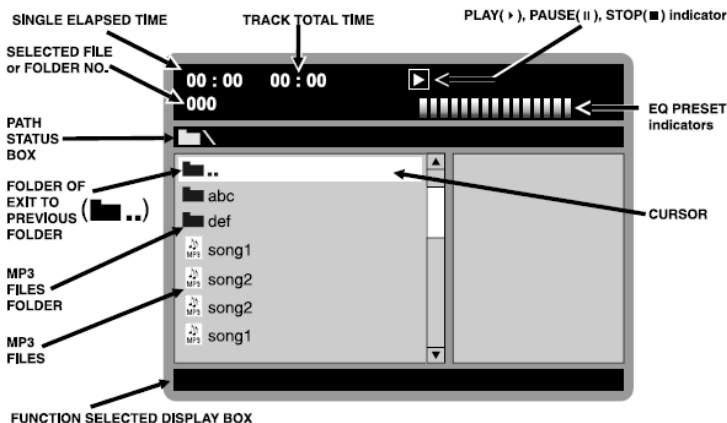

## Loading an MP3 CD

After the MP3 file browser appears on the screen, the root folder and the **STOP** "■" indication will appear.



## Playing an MP3 File in the Root Folder

Press the **NAVIGATION** (▲ / ▼) buttons to select your desired MP3 file in the root folder, and then press the **PLAY** (▶) button or **ENTER** to start playing. The **PLAY** "▶" indication will appear on the screen, and the player will continuously play all MP3 files in the root folder. It will stop automatically after playing all MP3 files.

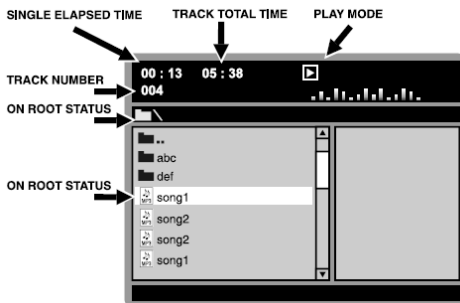

## BASIC OPERATION

### Playing an MP3 File in a folder

Press the **NAVIGATION** (▲ / ▼) buttons to select a folder, and then press the **NAVIGATION** (▶) button or **ENTER** button to enter the folder. Press the **NAVIGATION** (▲ / ▼) buttons to select your desired MP3 file in the folder, and then press the **PLAY** (▶) button or **ENTER** button to start playing the MP3 file. The **PLAY** "▶" indication will appear on the screen. It will continuously play all MP3 files in the folder and will stop automatically after playing all MP3 files.

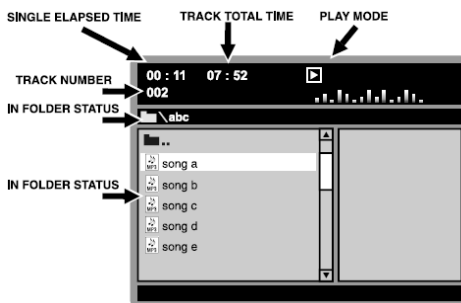

### Selecting the MP3 File Using Numeric Buttons

During the playback, press the corresponding **NUMERIC** buttons to the MP3 file number to select your desired MP3 file. It will jump to the selected MP3 file. Then press the **ENTER** button or the **PLAY** (▶) button to play the selected MP3 file.

### Going Back to the Previous MP3 Folder

When in a folder, use the **NAVIGATION** (▲ / ▼) buttons to select the folder symbol (■■■■) and press the **ENTER** button to go to the previous folder, or press the **NAVIGATION** (◀) button to go to the previous folder.

### Repeat Play of MP3 Files

To repeat a MP3 file, simply select and play a MP3 file. And then, press the **REPEAT** button once. The indication "**REPEAT ONE**" will appear on the LCD screen, and it will repeat the selected file continuously until the **STOP** (■) button is pressed. To repeat all MP3 files, press the **REPEAT** button once more. The indication "**REPEAT FOLDER**" will appear on the LCD screen, and it will repeat all MP3 files until the **STOP** (■) button is pressed. To exit the repeat mode, press the **REPEAT** button until the indication "**FOLDER**" appears on the screen.

## BASIC OPERATION

### Playing a JPEG CD

Please note that graphic files must be stored in the “JPEG” format (file extension .jpg). Otherwise, they will not be recognized. When you have inserted a CD with JPEG files, you will see a screen showing the folders and files contained on the CD.

1. Use the **NAVIGATION** (▲ / ▼) buttons to select the desired folder, and press the **ENTER** button to see the files inside the folder.
2. Use the **NAVIGATION** (▲ / ▼) buttons to select the desired file. The selected picture will be shown as a thumbnail picture on the right frame. Press the **ENTER** button to display the picture. It will also start the slide show of the pictures automatically until all the pictures in the CD have been shown on the screen once.
3. Press the **PAUSE** (||) button to hold the current picture on the screen. To continue the slide show, press the **PLAY** (▶) button again.
4. Use the **SKIP** (|◀◀ / ▶▶|) buttons to move to the previous or next picture.
5. Press the **STOP** (■) button to stop the slide show and return to the menu folder.
6. If you press the **REPEAT** button once, the current displayed picture will constantly be shown on the screen. Press the **REPEAT** button once more to have all pictures in the current folder repeated. Press the **REPEAT** button again to cancel the repeat mode.

**Note:** When you've selected the “**REPEAT ONE**” mode in the slide show, the selected picture will be displayed constantly. In this case, you cannot skip to the next or previous picture using the **SKIP** (|◀◀ / ▶▶|) buttons. To skip to the next or previous picture, please disable the “**REPEAT ONE**” mode.

## OPERATIONAL FEATURES

### Panel Key Lock

Press the **KEY LOCK** button on the remote control, and the indication “**Key Lock On**” will appear on the screen. At that point, the function buttons on the main unit are disabled. To make all the buttons function again, press the **KEY LOCK** button once more.

### Invalid Icon

The invalid icon “” will appear on the LCD screen if the corresponding function cannot be performed either on the inserted disc or in the selected mode. Please note that some functions depend on the disc type and the media on the disc.

### LCD Screen On / Off Function

When playing an audio CD, MP3 CD or other audio media disc, you can press the **SCREEN ON/OFF** button to turn off the LCD screen temporarily. This will save more power when using the built-in rechargeable battery for playing.

### Title Menu Feature

Press the **TITLE** button. The title menu of the disc will appear on the screen. Use the **NAVIGATION** (◀ / ▶ / ▲ / ▼) buttons to select the desired option, and then press the **ENTER** button to confirm. Some discs may not support this feature.

### DVD Menu Feature

Press the **DVD MENU** button to go to the main menu of the disc. Use the **NAVIGATION** (◀ / ▶ / ▲ / ▼) buttons to select the desired option on the main menu, and then press the **ENTER** button to confirm. Some discs may not support this feature.

### Subtitle Feature

Press the **SUBTITLE** button to select a subtitle language. To turn off the subtitle, press the **SUBTITLE** button repeatedly. Some discs may not support this feature.

### Audio Menu Feature

The **AUDIO MENU** button will allow you to change the audio language from the one selected at the initial settings to a different language when this function is available on DVD discs.

### Audio Mode

Press the **AUDIO MODE** button to cycle through the audio modes while playing an audio CD or VCD. The audio modes vary depending on the disc inserted, but include **MONO LEFT**, **MONO RIGHT**, **MIX MONO**, **STEREO**, etc. The indication “**DISC NOT SUPPORT**” will appear on the screen if a disc does not support this feature.

### Mute Function

Press the **MUTE** button once to mute the sound. The indication “**MUTE**” will appear on the LCD screen. Press the **MUTE** button again to restore the sound.

## OPERATIONAL FEATURES

### 3D Sound

During the playback of a disc, press the **3D** button repeatedly to change the sound mode as follows: **SURROUND ROCK** ⇒ **SURROUND POP** ⇒ **SURROUND LIVE** ⇒ **SURROUND DANCE** ⇒ **SURROUND TECHNO** ⇒ **SURROUND CLASSIC** ⇒ **SURROUND SOFT** ⇒ **SURROUND OFF** ⇒ **SURROUND ROCK**

### Zoom Function

This player can magnify a picture. Press the **ZOOM** button to zoom in or out the screen in the normal, slow or still play mode. It zooms in a picture by **x2**, **x3**, and **x4**. Use the **NAVIGATION** (◀ / ▶ / ▲ / ▼) buttons to select the desired part of the zoomed picture.

### PBC Function

When playing a VCD with PBC function, you can enjoy the simple interaction feature of VCD. By turning on this function, desired tracks can be selected by pressing the **NUMERIC** buttons. This feature is enabled only when a VCD2.0 disc supports the PBC feature. After selecting a track, press the **ENTER** button to start playing the selected track. Press the **PBC** button to activate and deactivate the PBC feature.

### Random Function

1. Press the **RANDOM** button once. The indication "**RANDOM**" will appear on the LCD screen.
2. Press the **PLAY** (▶) button. The unit will play all the tracks in the random order. After all tracks have been randomly played, the unit will automatically stop playing and enter into the **STOP** mode.
3. To cancel the random function, press the **RANDOM** button a second time. The indication "**OFF**" will appear on the LCD screen.

### Skip and Search Functions

1. **SKIP REVERSE** (◀◀) and **SKIP FORWARD** (▶▶) buttons: Use these buttons to go to the previous or next chapter on a DVD (or track on a CD).
2. **SLOW FORWARD** and **SLOW REVERSE** buttons: Use these buttons to play a movie in the forward (or reverse) slow motion at **1/2**, **1/4**, **1/8**, and **1/16** of a normal speed without the sound. This player does not support the slow-motion feature for Audio CD and MP3 CD. It also doesn't support the backward slow-motion feature for VCD. The invalid icon "⊖" will appear on the LCD screen if you press the **SLOW REVERSE** button while playing a VCD disc.
3. **PAUSE / STEP** (||) button: Use this button to pause the playback.
4. **SEARCH REVERSE** (◀◀) and **SEARCH FORWARD** (▶▶) buttons: These buttons allow searching chapters or tracks forward or backward with the speed of up to 16 times faster than the normal speed. Each press of the search buttons will change the speed as follows: **x2** ⇒ **x4** ⇒ **x8** ⇒ **x16**. Press the **PLAY** (▶) button to resume the normal playback.

## OPERATIONAL FEATURES

### Title / Chapter Search Function

Use this feature to directly go to a specific title and/or chapter.

1. While in the **PLAY** mode, press the **SEARCH** button once.
2. Use the **NAVIGATION** buttons (◀ / ▶) to select **TITLE**.
3. Use the **NUMERIC** buttons to input the desired title number.
4. Use the **NAVIGATION** buttons (◀ / ▶) to select **CHAPTER**.
5. Use the **NUMERIC** buttons to input the desired chapter number.

### Title / Time Search Function

Use this feature to directly go to a specific title and/or time.

1. While in the **PLAY** mode, press the **SEARCH** button twice.
2. Press the **NAVIGATION** buttons (◀ / ▶) to select **TITLE**.
3. Use the **NUMERIC** buttons to select the desired title number.
4. Press the **NAVIGATION** buttons (◀ / ▶) to select **TIME**.
5. Use the **NUMERIC** buttons to select the desired time.

**Note:** If the search function is attempted during the playback, you can only go to a specific chapter or time. You cannot change the title number. If you enter a time that exceeds the time limit of DVD, the indication **INPUT INVALID** will appear on the LCD screen. When playing a VCD, the numeric buttons can only be used to select the desired track or time in the search mode.

### Repeat Function

1. DVD Disc
  - a. While in the **PLAY** mode, press the **REPEAT** button once, and the indication "🔄 **CHAPTER**" will appear briefly on the LCD screen. Then, the current playing chapter will repeat continuously.
  - b. While in the **PLAY** mode, press the **REPEAT** button again, and the indication "🔄 **TITLE**" will appear briefly on the LCD screen. Then, the current playing title will repeat continuously.
  - c. Press the **REPEAT** button once more to cancel the **REPEAT** function.
2. Audio CD / VCD Disc
  - a. To repeat a track, simply select the track as described in the "**Skip and Search**" section, and then press the **REPEAT** button once. The indication "🔄 **TRACK**" will appear on the LCD screen. The selected track will then repeat continuously until the **STOP** (■) button is pressed.
  - b. To repeat all tracks on an Audio CD or VCD, press the **REPEAT** button again. The indication "🔄 **ALL**" will appear on the LCD screen. All tracks will then repeat continuously until the **STOP** (■) button is pressed.
  - c. To cancel the repeat play, press the **REPEAT** button until the indication "**OFF**" appears on the LCD screen.



## OPERATIONAL FEATURES



### A-B Repeat Function

This player can repeatedly play a specific section of a track or chapter. This function does not work with a MP3 CD.

1. While in the **PLAY** mode, press the **A-B** button to define where you want the section to start.
2. Press the **A-B** button again to define where you would like the section to end. The unit will play the selected area continuously.
3. To cancel the **A-B REPEAT** mode, press the **A-B** button again until the icon disappears on the screen.

### Viewing from a Different Camera Angle (Multi-Angle)

Some DVD discs may contain scenes which have been shot simultaneously from a number of different camera angles. This function depends on the disc.

1. Play a DVD disc that is recorded with multiple angles.
2. Press the **ANGLE** button. If a different angle is available, the camera icon “” will appear on the screen.
3. Press the **ANGLE** button again to see the movie with the different angle. Each press of the **ANGLE** button will show the movie with a different angle.
4. To return the normal angle view, press the **ANGLE** button until the camera icon “” disappears.

### Programmed Playback

This unit has the programmable memory that allows you to program up to 20 tracks (or chapters) on any disc for playback in any desired order. You can also program certain tracks (or chapters) to play more than once. This feature doesn't support MP3 discs. To perform the programmed playback, proceed as follows:

1. While in the **STOP** mode, press the **PROGRAM** button. The program window will appear on the screen.
2. Press the **NUMERIC** buttons to input two numbers for each track: one for title and the other for chapter. After inputting two numbers, the cursor will automatically jump to the next program track, awaiting the input of the next numbers.
3. Repeat step 2 until all the desired titles and chapters have been programmed (up to 20). You can repeat a title and a chapter more than once if desired.
4. Use the **NAVIGATION** (◀ / ▶ / ▲ / ▼) buttons to select the **START** option, and then press the **PLAY** (▶) button to begin the programmed play.
5. To cancel the program function, press the **STOP** (■) button twice.

## OPERATIONAL FEATURES

### Display Feature

Press the **DISPLAY** button to show the elapsed and remaining time of the playing disc. Each time the **DISPLAY** button is pressed, the displayed time mode will change on the screen as follows:

1. DVD: Title Elapsed ⇄ Title Remain ⇄ Chapter Elapsed ⇄ Chapter Remain ⇄ Display Off
2. VCD & AUDIO CD: Single Elapsed ⇄ Single Remain ⇄ Total Elapsed ⇄ Total Remain ⇄ Display Off
3. MP3 CD: Single Elapsed ⇄ Single Remain

### Bookmark Feature

Storing bookmarks in the memory to be viewed later is similar to marking your page in a book. You can quickly go to any point on the disc with this bookmark feature. Some discs may not support this feature. 12 bookmarks can be memorized for a disc.

1. To Program Bookmarks:
  - a. Press the **BOOKMARK** button to enter the bookmark mode in the play mode.
  - b. Use the **NAVIGATION** (◀ / ▶) buttons to go to the empty bookmark space.
  - c. Press the **PLAY** (▶) button to mark the desired position.
  - d. Press the **BOOKMARK** button to exit the bookmark mode.
  - e. Press the **SKIP** (|◀◀ / ▶▶|) or **SEARCH** (◀◀ / ▶▶) buttons to go to the desired position in another chapter or title.
  - f. Repeat **step a** through **step e** to program the remaining bookmarks.
2. To Play Programmed Bookmarks:
  - a. Press the **BOOKMARK** button to enter the bookmark mode.
  - b. Use the **NAVIGATION** (◀ / ▶) buttons to select your desired bookmark, and then press the **PLAY** (▶) button to confirm. It will automatically go to the bookmarked position and start playing the disc at the position.
  - c. Repeat **step a** and **step b** to play other bookmarked positions.
3. To Clear Bookmarks:
  - a. Press the **BOOKMARK** button to enter the bookmark mode.
  - b. Use the **NAVIGATION** (◀ / ▶) buttons to select the old bookmark, which you want to clear.
  - c. Press the **CLEAR** button to erase the old bookmark.
  - d. Exit the bookmark mode by pressing the **BOOKMARK** button.
  - e. Or open the disc compartment cover.

## OPERATIONAL FEATURES

### Digest Function

#### 1. DVD / VCD DIGEST

- a. Press the **DIGEST** button during the playback, and the screen will switch to a thumbnail view. There are two types of digest screens available from the “**Select Digest Type**” menu, **Track Digest** and **Disc Interval**.

- b. Track Digest (Title Digest & Chapter Digest)

- i. The screen will show the starting picture of all tracks (or chapters). Enter the desired track (or chapter) number by using the **NUMERIC** buttons, and then press the **ENTER** button to confirm. It will play from that track (or chapter) onwards.
- ii. The screen will only show only 6 tracks (or chapters). If there are more than 6 tracks (or chapters) available on a disc, press the **SKIP FORWARD (▶▶)** button to look at the remaining tracks (or chapters) on the next screen.
- iii. Choose the **EXIT** option to exit the “**Track Digest**” screen.
- iv. Choose the **MENU** option to return to the “**Select Digest Type**” menu.

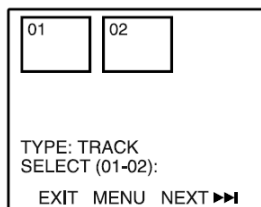

- c. Disc Interval (Title Interval & Chapter Interval)

- i. The screen shows the starting picture of 10-minute intervals on the screen simultaneously. Enter your desired interval by using the **NUMERIC** buttons, and then press the **ENTER** button to confirm it. It will play from that interval onwards.
- ii. The screen will only show only 6 intervals. If there are more than 50 minutes available on a disc, press the **SKIP FORWARD (▶▶)** button to look at the remaining intervals on the next screen.
- iii. Choose the **EXIT** option to exit the “**Disc Interval**” screen.
- iv. Choose the **MENU** option to return to the “**Select Digest Type**” menu.

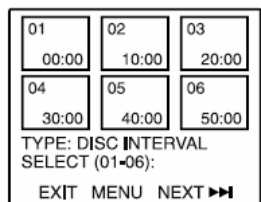

#### 2. AUDIO CD DIGEST

- a. Press the **PLAY (▶)** button to start CD playback from track No. 1
- b. Press the **DISPLAY** button to display the elapsed time.
- c. Press the **DIGEST** button to activate the CD scanning function.
- d. The first 6 seconds of each track on the CD will display on the screen until all the CD tracks finish playing the 6-second introduction.



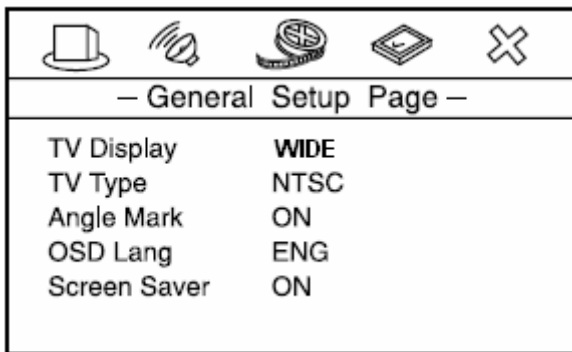

# SETTING UP YOUR DVD PLAYER

## Navigating the Setup Pages

1. Press the **SETUP** button in the **STOP** mode to display the setup page. The Setup Page will appear as below:



2. Use the **NAVIGATION** (◀ / ▶) buttons to browse the setup menu. The icons on the top of the setup menu represent as follows:

	General Setup Page
	Speaker Setup Page
	Video Setup Page
	Preference Page
	Exit Setup

3. Move to one of the options available in the selected setup page, using the **NAVIGATION** (▲ / ▼) buttons.
4. Press the **NAVIGATION** (▶) button to access the sub-menu of the selected option.
5. Use the **NAVIGATION** (▲ / ▼) buttons to select an option in the sub-menu.
6. Press the **ENTER** button to confirm your selection.
7. Press the **NAVIGATION** (◀) button to return to a previous menu.
8. Press the **SETUP** button, or select the icon “✕” and press the **ENTER** button to exit the setup menu completely.

## SETTING UP YOUR DVD PLAYER



### General Setup Page

1. TV DISPLAY: Normal/PS, Normal/LB, Wide
  - a. Normal/PS: "PS" stands for "Pan Scan". Select this option when the unit is connected with a normal (4:3 aspect ratio) TV. If a wide-screen image is displayed on the screen, some left and right edges of the image are cut out automatically.
  - b. Normal/LB: "LB" stands for "Letter Box". Select this option when the unit is connected with a normal (4:3 aspect ratio) TV. If a wide-screen image is displayed on the screen, the displayed image is automatically fit into the screen, and the image will be displayed with some degree of distortion.
  - c. Wide: Select this option when the unit is connected to a wide-screen (16:9 aspect ratio) TV.
2. TV TYPE: NTSC / PAL
  - a. NTSC: When connected to a NTSC TV system, this option must be selected to display an image correctly.
  - b. PAL: When connected to a PAL TV system, this option must be selected to display an image correctly.
3. ANGLE MARK: ON / OFF
  - a. ON: If selected, it will show the angle mark on the screen when playing a DVD recorded with the multi-angle view. This only works when there is an angle mark on the disc.
  - b. OFF: If selected, the angle mark will not be shown on the screen.
4. OSD LANG: English / Spanish / German / French / Italian
  - a. Used to change the on-screen display language.
5. SCREEN SAVER: ON / OFF
  - a. ON: Activate the screen saver
    - i. The screen saver image appears when the unit stops or the image is motionless for approximately 1 minute. This saver can keep the screen from being damaged.
  - b. OFF: Disable the screen saver



### Speaker Setup Page

1. Speaker Setup: LT/RT, STEREO
  - a. LT/RT: Select to hear the sound in the theatrical Downmix mode.
  - b. STEREO: Select to hear the sound in the stereo Downmix mode.

## SETTING UP YOUR DVD PLAYER



### Video Setup Page

1. Sharpness – To adjust the sharpness of a picture
  - a. Use the **NAVIGATION** (▲ / ▼) buttons to select your desired level. The color bar will appear on the screen while adjusting the sharpness.
  - b. Press the **ENTER** button to confirm.
2. Brightness – To adjust the lightness and darkness of a picture
3. Contrast – To increase or decrease picture contrast
4. Color – To increase or decrease color intensity
5. Tint – To increase or decrease the phases of color
  - a. Use the **NAVIGATION** (▲ / ▼) buttons to increase or decrease the level of tint.
  - b. Press the **ENTER** button to confirm.



### Preference Setup Page

1. Audio – To change the audio language, choose the language using the **NAVIGATION** (▲ / ▼) buttons and press the **ENTER** button to confirm.
2. Subtitle – To change the subtitle language, choose the language using the **NAVIGATION** (▲ / ▼) buttons and press the **ENTER** button to confirm.
3. Disc Menu – To change the language of the menu, choose the language using the **NAVIGATION** (▲ / ▼) buttons and press the **ENTER** button to confirm.

## CARE AND MAINTENANCE GUIDE

- Treat the disc carefully. Handle the disc only by its edges. Never allow your fingers to contact with the shiny, unprinted side of the disc.
- Do not attach adhesive tape, stickers etc., to the disc label.
- Clean the disc periodically with soft, lint-free, dry cloth. Never use detergents or adhesive cleaners to clean the disc. If necessary, use a CD or DVD cleaning kit.
- If disc skips or gets stuck on a section of the disc, it is probably dirty or damaged (scratched).
- When cleaning the disc, wipe in straight lines from the center of the disc to the edge of the disc. Never wipe in circular motions.
- To remove a disc from its storage case, press down on the center of the case and lift the disc out, holding it carefully by the edges.
- Fingerprints and dust should be carefully wiped off the disc's recorded surface with a soft cloth. Unlike conventional records, compact disc have no groove to collect dust and microscopic debris, so gently wiping with a soft cloth should remove most particles.



### Cleaning the Unit

- To prevent fire or shock hazard, disconnect your unit from the AC power source when cleaning.
- The finish on the unit may be cleaned with a dust cloth and cared for as other furniture, Use caution when cleaning and wiping the plastic parts.
- If the cabinets become dusty wipe them with a soft dry dust cloth. Do not use any wax or polish sprays on the cabinets.
- If the front panel becomes dirty or smudged with fingerprints it may be cleaned with a soft cloth slightly dampened with a mild soap and water solution. Never use abrasive cloths or polishes as these will damage the finish of your unit.

**Caution:** never allow any water or other liquids to get inside the unit while cleaning.

## TROUBLESHOOTING GUIDE

### **It doesn't display the iPod videos on the 7" LCD screen.**

- Turn on the DVD player. You can find the power switch on top of the DVD player, named as "**POWER**". Set the "**POWER**" switch to the "**ON**" position.
- Check whether the "**LINE SELECT**" switch is set to the "**iPod**" position. In order to display your iPod videos on the 7" LCD screen, it must be set to "iPod".
- Check the TV settings of your iPod. The "**TV out**" option of your iPod must be set to "**On**". You can refer to the section "**Watching Your iPod Videos on the 7" LCD Screen**" in this manual for the related instructions, or you can also refer to the user manual of your iPod.
- Your iPod is not in the play mode. Play the video on your iPod.

### **It doesn't charge the iPod.**

- Check whether the AC adapter is connected. In order to charge your iPod, the AC adapter must be connected to the DVD player.
- Check whether your iPod is properly installed into the dock.

### **The remote control and control buttons on the main unit doesn't work on iPod.**

- It is normal. This unit doesn't have a control on your iPod due to the limited navigation system of iPod with video (30GB, 60GB).

### **No power on the unit**

- Insert the AC power plug securely into the power outlet.

### **It fails to start playing even when the PLAY (▶) button is pressed. It will start playing but then stop immediately.**

- Condensation has been formed. Wait about 1 to 2 hours to allow the player to dry out.
- This player cannot play a disc other than DVD, Video CD and CD.
- The disc may be dirty and may require cleaning.
- Ensure that the disc is installed with the label side up.

### **No picture on the LCD screen**

- Ensure that the **LINE SELECT** switch is properly set.
- Ensure that the external video device or iPod is properly connected.

### **No sound or distorted sound**

- Ensure that the **LINE SELECT** switch is properly set.
- Ensure that the external device or iPod is properly connected.
- Ensure that the input settings for the external audio device or iPod are properly set.

### **Picture is distorted during the rapid advance or rapid reverse.**

- The picture will be somewhat distorted at times. This is normal.



## TROUBLESHOOTING GUIDE

### **No rapid advance (or rapid reverse) playback**

- Some discs may have sections which prohibit the rapid advance (or rapid reverse.)

### **No 4:3 (16:9) picture display**

- Choose the correct "TV SCREEN" option in the video setup page.

### **No operations can be performed with the remote control unit.**

- Check the batteries are installed with the correct polarities (+ and -).
- The batteries may be exhausted. Replace them with new ones.
- Point the remote control unit at the remote control sensor and attempt operation.
- Operate the remote control at a distance of not more than 6m from the remote control sensor.
- Remove the obstacles between the remote control unit and remote control sensor.

### **No key operation (with the main unit and/or the remote control unit) is effective.**

- Press the **POWER** button to set the player to the standby mode and then switch back on.
- Press the **POWER** button to set the player to the standby mode, disconnect the power plug, and then reconnect it.

### **No menu play**

- This function works only for Video CDs with playback control.

### **Audio and/or subtitle language are not shown on the disc or not in the setup menu.**

- If the audio and/or subtitle language does not exist on the language selected in the setup menu, it will not be seen or heard.

### **No subtitles**

- Subtitles appear only with discs which contain them.
- Subtitles are cleared from the TV monitor. Perform the steps in the subtitle setup instruction to display the subtitles.

### **Alternative audio (or subtitle) language fails to be selected.**

- An alternative language is not selected with discs which do not contain more than one language.

### **The movie angle cannot be changed.**

- This function is contingent on software availability. Even if a disc has a number of angles recorded, these angles may be recorded for specific scenes only.

### **When an AC adapter is plugged in for a while, the FULL and CHARGE indicators blink. Then, the CHARGE indicator will light up RED, but the rechargeable battery is released.**

- It is a system test for the recharge circuit, which is not a malfunction.

## SPECIFICATIONS

- Power Requirements
  - Main Unit: DC 10V – 11V, Max 1.4A
  - AC Adapter
    - Input: AC 100V – 240V, 60Hz/50Hz
    - Output: DC 10V, 1.4A
  - Car Adapter
    - Input: DC 12V – 24V
    - Output: DC 10V, 1.6A
- Power Consumption: 11W max.
- Signal System: NTSC / PAL
- Operating Temperature Range: 5°C to 35°C (41°F to 95°F)
- Operating Humidity Range: 5% to 90% (no condensation)
- Battery Charging Time: Approximately 4 - 5 hours
- Battery Life (Fully charged): 2.5 hours
- Video Output Level: 1Vpp
- Audio Output Level: 1Vrms (1 kHz, 0dB)
- Frequency Responses
  - DVD (Linear Audio)
    - 20Hz-20kHz (48kHz Sampling)
    - 20Hz-20kHz (96kHz Sampling)
  - CD Audio
    - 20Hz-20kHz
- S/N Ratio: 70dB
- Wow and flutter: below measurable level
- Pickup
  - Wave length: 655nm
  - Laser power: CLASS 1

\* Specifications are subject to change without prior notice.



**iLuv™**

**TEL: 516-626-7188**

**FAX: 516-626-7105**

**website: [www.i-Luv.com](http://www.i-Luv.com)**

**e-mail: [info@i-Luv.com](mailto:info@i-Luv.com)**

iLuv is a trademark of jWIN Electronics Corp. iPod is a trademark of Apple Computer Inc. All logos and brands are property of their respective owners. iPod is not included in this package. Features and specifications are subject to change without prior notification.

© 2006 jWIN Electronics Corp. All rights reserved. No portion of this printing material or product enclosed herewith including design, shape and graphics, may be not reproduced or transmitted in any form without the expressed written consent of jWIN Electronics Corp. by any means, electronics or mechanical, including photocopy, recording or information storage and retrieval system. Any unauthorized distribution or reproduction of this printing material or product, or any portion there of, will be prosecuted to the fullest possible extent of the law.